

# Cal Flame®

THE HOME RESORT EXPERIENCE



Outdoor Room  
Equipment  
2014  
Presented by  
HEALTHY-KIDS



## Award-Winning Hearth and Barbecue Manufacturer

Cal Flame is an award-winning hearth and barbecue manufacturer that offers innovative backyard solutions for every home and budget. The feature-rich Cal Flame lineup includes grills, grilling and drop-in accessories, customized outdoor kitchens, KD barbecue islands, custom barbecue carts, fireplaces and firepits. Best of all, Cal Flame offers you peace of mind knowing that all Cal Flame products are ETL and CE listed for your safety. With Cal Flame, your dream backyard is finally within reach!

## Gourmet Grilling at its Finest



Only Cal Flame offers an extensive line of drop-in grills every BBQ enthusiast and grilling preference, from charcoal to convection. Like all Cal Flame products, Cal Flame drop-in grills are engineered using the latest technology and product innovations. Cal Flame's exclusive removable V-shaped grill grates have been designed to lock in the heat and prevent smaller food from falling through. Cal Flame grills also offer 25% more grilling capacity than other grill manufacturers and feature independent knobs with an exclusive patented design.



## Barbecue Cart for Every Backyard

The A La Cart Series is the perfect solution for any grill master that is short on space but looking for a top-of-the-line cart for their grill. This series allows you to select the cart size and storage space you need, along with any Cal Flame grill and standard single side burner. The carts feature two removable side/serving trays, a spice rack, bottle opener, towel and paper towel holders, two drawers, and a bottom compartment for a propane tank or additional storage.



## Entertain with a Wide Variety of Gourmet Barbecue Accessories

Turn an ordinary barbecue island into a state-of-the-art outdoor kitchen with Cal Flame barbecue accessories. Only Cal Flame offers all the gourmet necessities you need to build a true outdoor kitchen. With Cal Flame, you can accessorize your barbecue island or cart to create the outdoor kitchen solution of your dreams. Cal Flame eliminates the need to run inside during a backyard barbecue by providing the convenience of an indoor kitchen...without the walls.



## State-of-the-Art Outdoor Kitchen

A Cal Flame outdoor kitchen is the perfect way to extend your living space and add value to your home. You can choose the barbecue island that's right for you from the widest selection in the industry –from 4 ft. to 10 ft. barbecue islands. With Cal Flame, you can customize your barbecue island with the gourmet grill and accessories of your choice. Complete the look of your island with your choice of granite, porcelain tile or natural stone tile countertops, and stucco or cultured stone base finishes –available in an array of elegant base designs. Choose from the widest range of barbecue island designs in various configurations to complement your personal Home Resort design, lifestyle and backyard landscape.



## Extend the Outdoor Season

Cal Flame outdoor fireplace and firepits are the perfect way to extend the outdoor season and seek warmth in the great outdoors. The innovative Cal Flame outdoor fireplaces and firepits feature all the latest technology and allow you to enjoy cool evenings while entertaining family and friends in your own private backyard retreat. A Cal Flame outdoor fireplace or firepit instantly adds a warm glow to your outdoor home resort, creating a calm, inviting ambiance. Cal Flame outdoor fireplaces and firepits can be customized to fit your personal taste and complement any backyard landscape. Designed with the finest material and craftsmanship, Cal Flame outdoor fireplaces and firepits are built to withstand all outdoor elements for years of enjoyment. Cal Flame outdoor fireplaces feature a 316-galvanized steel frame, sturdy one-piece construction, ETL approval and have a liquid propane/natural gas option.

# A HISTORY OF AWARD WINNING EXCELLENCE

Over the years, Cal Flame has earned a reputation for producing quality bbq islands, bbq carts, bbq hardware, fireplaces and firepits that are at the forefront of innovation & design. Cal Flame is honored to have its home resort and bbq products so highly regarded by *Hearth & Home Magazine* - Honoring Innovation in Design and Technology for the Hearth, Patio and Barbecue Industry.

Cal Flame continues to be the leader in innovation and designs in all Cal Flame categories, creating the ultimate outdoor living experience.

Cal Flame also supports the local community by donating products to foundations like The Boys & Girls Club, Weingart Center Association and more. Cal Flame products can also be found in local and national publications and seen on popular national television shows!





# BUILT-IN TOP GUN™ 5-BURNER CONVECTION GRILL

The innovative Top Gun™ 5 Burner Convection Grill has been designed to fit any Cal Flame barbecue cart or island! It features five cast stainless steel burners and a powerful centrifugal fan that uniformly circulates heat throughout the grilling area. It also features a glass window on the hood for your grilling convenience and a striking new light feature on each stainless steel knob - a Cal Flame exclusive!



## BBQ Grill Top Gun™ 5-Burner Convection Grill

Model No.: BBQ13875CTG

**Dimensions:** 39"W x 22 7/16"H x 24"D

**Cut-Out Dimensions:** 38 1/4"W x 9"H x 22 1/4"D

**BTU:** Five (5) 15,000 BTU Cast Stainless Steel Burners  
Two (2) 9,000 BTU Ceramic Core Infrared Burners  
One (1) 2,500 BTU Stainless Steel Burner

**Total BTU:** 95,000

## FEATURES

- Patented Convection Technology
- Patented Cast Stainless Steel Knobs with multi-colored LED Bezels
- Seamless Design with Durable 304-Stainless Steel Construction
- 1,000 sq. in. Cooking Surface
- Removable Heavy-Duty Grates with V-Grate Cooking Design
- Glass Viewing Window
- Dual Halogen Interior Lights
- Independent Burner Ignition System
- Two-Position Full-Width Warming Rack
- Rotisserie with Adjustable Motor Mount
- Full Width Stainless Steel Drip Tray on Rollers
- Built-In Temperature Gauge
- Built-In Smoker Box with dedicated burner
- Vented Knob Splash Guards
- Burner Lip Guards
- Natural Gas Conversion Kit



**Exclusive**

## PATENTED CONVECTION TECHNOLOGY

An option once only found in the kitchen is now available for the cooking enthusiast outdoors. Convection cooking uses high velocity fans to distribute hot air throughout the entire cavity of the grill when the grill hood is shut. By circulating hot air, cooking times are greatly reduced and food is cooked evenly. Compared to conventional barbecue grills, cooking with a convection grill offers faster pre-heat times, reduced gas consumption, and increased cooking control.

High velocity fans located at the rear of the grill circulates heated air around and against the food creating an overall ambient temperature. The result of this motion is even baking and delightful textures.





# CONVECTION Y

Convection barbecue grills also reduce cooking times up to 30% and use up to 25% less fuel than traditional barbecue grills. By adding convection control to a barbecue grill, grilling enthusiasts can now enjoy the convenience of baking outdoors while grilling their favorite meats, vegetables and poultry at the same time.



Cal Flame exclusive custom knobs feature one-hand operation with an individual ignitor per burner.

# BUILT-IN CONVECTION BARBECUE GRILLS

Gourmet recipes are ready to serve faster with convection cooking. Made of solid 304-stainless steel, our burners emit up to 93,000 BTU with our 5-burner grill (72,000 BTU – 4-burner grill) and have a ten year warranty. Cal Flame Convection Grills are also equipped with premium features and added value.



## BBQ Grill **Convection** 5 Burner

Model No.: BBQ13875CP

**Dimensions:** 39"W x 22 7/16"H x 24"D

**Cut-Out Dimensions:** 38 1/4"W x 9"H x 22 1/4"D

**BTU:** Five (5) 15,000 BTU Cast Stainless Steel Burners  
Two (2) 9,000 BTU Ceramic Core Infrared Burners

**Total BTU:** 93,000

## FEATURES

- Patented Convection Technology
- Patented Cast Stainless Steel Knobs
- Seamless Design with Durable 304-Stainless Steel Construction
- 5 Burner-1,000 sq. in. Cooking Surface;
- 4 Burner-800 sq. in. Cooking Surface
- Removable Heavy-Duty Grates with V-Grate Cooking Design
- Dual Halogen Interior Lights
- Independent Burner Ignition System
- Two-Position Full-Width Warming Rack
- Rotisserie with Adjustable Motor Mount
- Full Width Stainless Steel Drip Tray on Rollers
- Built-In Temperature Gauge
- Vented Knob Splash Guards
- Burner Lip Guards
- Natural Gas Conversion Kit



## BBQ Grill **Convection** 4 Burner

Model No.: BBQ13874CP

**Dimensions:** 31 3/4"W x 22 7/16"H x 24"D

**Cut-Out Dimensions:** 30 7/8"W x 9 1/2"H x 22 1/4"D

**BTU:** Four (4) 15,000 BTU Cast Stainless Steel Burners  
One (1) 12,000 BTU Ceramic Core Infrared Burners

**Total BTU:** 72,000



# BUILT-IN P SERIES™ BARBECUE GRILL

Cal Flame has introduced many industry firsts that revolutionized the way grills are made and offer design features that grilling enthusiasts expect from today's modern outdoor grills. The Cal Flame P-Series Grills are no exception to the rule. Each P-Series Grill is crafted using 304-stainless steel and includes signature features such as cast stainless steel burners with independent ignitor switches and heavy duty V-patterned grates on a large cooking surface.



**P-Griddle Tray**  
Enjoy favorites like eggs or bacon with this griddle tray.

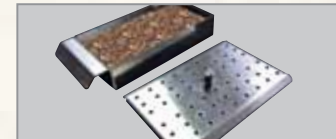

**P-Smoke Tray**  
Infuse your Cal Flame grill with the smoky flavor everyone loves with this convenient smoke tray that fits any Cal Flame grill!



**P-Grill Cover**  
This grill cover keeps your Cal Flame Built-In Barbecue Grill looking its best by protecting it against weather damage. Cover fits 4 and 5 burner P-Series grills.

## BBQ Grill P Series P5

Model No.: BBQ13P05

**Dimensions:** 39"W x 22 7/16"H x 24"D

**Cut-Out Dimensions:** 38 1/4"W x 9"H x 22 1/4"D

**BTU:** Five (5) 15,000 BTU Cast Stainless Steel Burners

Two (2) 9,000 BTU Ceramic Core Infrared Burners

**Total BTU:** 93,000

## FEATURES

- Patented Cast Stainless Steel Knobs
- Seamless Design with Durable 304-Stainless Steel Construction
- P5-1,000 sq. in. Cooking Surface;  
P4-800 sq. in. Cooking Surface
- Removable Heavy-Duty Grates with V-Grate Cooking Design
- Dual Halogen Interior Lights
- Independent Burner Ignition System
- Two-Position Full-Width Warming Rack
- Rotisserie with Adjustable Motor Mount
- Full Width Stainless Steel Drip Tray on Rollers
- Built-In Temperature Gauge
- Vented Knob Splash Guards
- Burner Lip Guards
- Light Switch with LED Bezel
- P-Griddle Tray
- P-Smoker Box
- P-Grill Cover



## BBQ Grill P Series P4

Model No.: BBQ13P04

**Dimensions:** 31 3/4"W x 22 7/16"H x 24"D

**Cut-Out Dimensions:** 30 7/8"W x 9 1/2"H x 22 1/4"D

**BTU:** Four (4) 15,000 BTU Cast Stainless Steel Burners

One (1) 12,000 BTU Ceramic Core Infrared Burners

**Total BTU:** 72,000



# BUILT-IN G-SERIES™ BARBECUE GRILL

Cal Flame's G-Series Grills are the perfect heavy-duty grills for first-time buyers searching for value. G-Series grills are constructed of 430-stainless steel, built with two-layer walls and feature Cal Flame's proprietary V-Grates, a temperature gauge, and porcelain-coated cast iron burners. Designed to pair with any Cal Flame Barbecue Island or Grill Cart, G-Series grills offer multiple upgrades and boost enough BTU-power to meet the needs of any culinary enthusiast.



## BBQ Grill G Series 5 Burner

Model No.: BBQ09G05

**Dimensions:** 39"W x 22 7/16"H x 24"D

**Cut-Out Dimensions:** 38 1/4"W x 9"H x 22 1/4"D

**BTU:** Five (5) 15,000 BTU Cast Iron, Porcelain Coated Burners

**Total BTU:** 75,000

## FEATURES

- Patented Cast Stainless Steel Knobs
- Heavy Duty Porcelain Coated Cast Iron Burners
- Seamless Design with Durable 430-Stainless Steel 16-Gauge Construction
- G5-1000 sq. in. Cooking Surface;  
G4-800 sq. in. Cooking Surface;  
G3-600 sq. in. Cooking Surface
- Removable Heavy-Duty Grates with V-Grate Cooking Design
- Independent Burner Ignition System
- Two-Position Full-Width Warming Rack
- Full Width Stainless Steel Drip Tray on Rollers
- Built-In Temperature Gauge
- Vented Knob Splash Guards
- Burner Lip Guards



## BBQ Grill G Series 4 Burner

Model No.: BBQ08G04

**Dimensions:** 31 1/2"W x 22 7/16"H x 24"D

**Cut-Out Dimensions:** 30 7/8"W x 9 1/2"H x 22 1/4"D

**BTU:** Four (4) 15,000 BTU Cast Iron, Porcelain Coated Burners

**Total BTU:** 60,000



## BBQ Grill G Series 3 Burner

Model No.: BBQ09G03

**Dimensions:** 24 1/2"W x 22 7/16"H x 24"D

**Cut-Out Dimensions:** 23 1/2"W x 9 1/2"H x 22 1/4"D

**BTU:** Three (3) 15,000 BTU Cast Iron, Porcelain Coated Burners

**Total BTU:** 45,000



# BUILT-IN G SERIES™ CHARCOAL BARBECUE GRILL

For barbecue purists there is no substitute for a charcoal grill. Charcoal burns at a higher temperature than gas, allowing a skilled grill master to easily sear meat. This 800 sq. in. charcoal grill features sturdy 430-stainless steel construction as well as a temperature gauge and exclusive V-patterned grates. An ergonomically designed handle easily cranks the charcoal tray to your desired height giving you the control you need to adjust the distribution of heat produced from your charcoal briquettes. Including a charcoal grill to your outdoor kitchen is a perfect choice for recipes that require a traditional smoke flavor.



## BBQ Grill **G Series** Charcoal

Part Number: BBQ09G870

**Dimensions:** 31 3/4" x 21" x 22 7/16"

**Cut-Out Dimensions:** 30 7/8" x 19" x 9 1/2"

## FEATURES

- Seamless Design with Durable 430-Stainless Steel 16-Gauge Construction
- 800 sq. in. Cooking Surface
- Removable Heavy-Duty Grates with V-Grate Cooking Design
- Adjustable Charcoal Tray with Handle Crank System
- Two-Position Full-Width Warming Rack
- Built-In Temperature Gauge
- Handle Crank Splash Guard





# BARBECUE GRILL ACCESSORIES

Cal Flame is the first and only manufacturer to offer you the commercial-grade equipment to build a true outdoor kitchen. The very best in stainless steel grills and cooking equipment can now be yours. Side burners, food warmers and outdoor refrigerators eliminate the need to run inside and keep you where you want to be the most- at the grill!

## ROAST



### Rotisserie & Motor

Part Numbers: BBQ08856P3-4-5 (3, 4 or 5 Burner Grills);  
BBQ07100781-CC (12V Motor)

Enjoy the full bodied taste of rotisserie cooking with rotisseries that can be mounted in left or right configurations!

Dimensions: 32-1/2"W for 3 Burner • 40"W for 4 Burner  
47-1/2"W for 5 Burner • 5"x 4-1/4"W x 2-3/4"H for Motor

## DEEP FRY



### Deep Fryer Accessories Helper Set

Part Number: BBQ09902

Turn part of your grill into a deep frying station with this deep fryer helper. You'll love preparing tasty fries!

Dimensions: 14-1/2"W x 19-1/4"D x 4"H

## ROAST

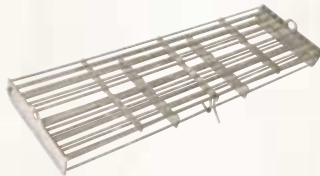

### Rotisserie Basket

Part Number: BBQ08892

Perfect for roasting vegetables or cooking fish, this rotisserie basket makes preparing these foods and others easy!

Dimensions: 17-7/8"W x 5-1/2"D x 1-1/2"H

## BAKE



### Pizza Brick Tray

Part Number: BBQ07900

Give your pizza that brick oven flavor with this pizza brick tray. Keep the kids satisfied at every BBQ party!

Dimensions: 15-1/8"W x 20-1/4"D x 1-1/2"H

## SEAR

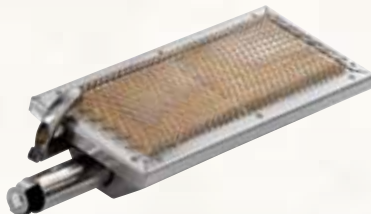

### Sear Zone Burner

Part Number: BBQ07890P

Lock in the juice by searing your BBQ with this high-heat sear zone that replaces one of the grill burners.

Dimensions: 5-3/8"W x 12-1/2"D x 3-5/16"H

## SMOKE



### Smoke Tray

Part Number: BBQ08854P

Infuse your outdoor BBQ with smoky flavor everyone loves with this convenient smoke tray that fits in your grill over any burner.

Dimensions: 5-1/4"W x 17-1/8"D x 2-1/2"H

## GRIDDLE



### Griddle Tray w/ Storage

Part Number: BBQ07862P

Enjoy fried foods like eggs with this griddle tray that comes with its own storage that blends with your island!

Dimensions: 15-3/8"W x 19-3/4"D x 4-1/2"H

Cut Out Dimen: 13-1/2"W x 19-5/8"D x 2-3/4"H

## CHARCOAL

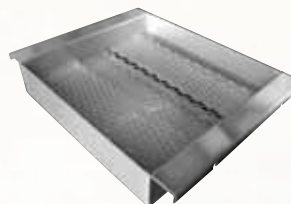

### Charcoal Helper Tray

Part Number: BBQ11859

Turn part of your Cal Flame grill into a charcoal & gas grill. Load removable tray with charcoal of your choice.

Dimensions: 13-5/8"W x 17-5/8"D x 3"H



# BARBECUE ISLAND ACCESSORIES

Convenient side burners make it easy to prepare multiple meals while you grill. Cook soups, stews and skillet dishes without having to run inside. Choose single and double side burners in the style that complements your backyard design. Drop-in accessories give you the functionality you need to handle any event in your backyard or garden. Keep side dishes fresh with food warmers and make any drink with cocktail centers and ice chests. At Cal Flame, it's all about choice.

## SIDE BURNERS



### Deluxe Double Side By Side Burner

Part Number: BBQ13954P

Never reach over a hot pot or pan with a raised deluxe side by side burner.

**Dimensions:**

26"W x 14"D x 10-1/2" H

**Cut Out Dimensions:**

25"W x 13-3/8"D x 7-1/4"H



### Standard Side By Side Flat Burner

Part Number: BBQ08953P

The standard side-by-side burner is perfect for preparing tasty side dishes like soups, sauces or finger foods.

**Dimensions:**

28"W x 20-3/4"D x 6-5/8"H

**Cut Out Dimensions:**

26-5/8"W x 19-3/4"D x 4"H



### Deluxe Double Side Burner

Part Number: BBQ13899P

Maximize your counter space while preparing delicious side dishes with an inline double side burner.

**Dimensions:**

13"W x 21-1/2"D x 11-7/8"H

**Cut Out Dimensions:**

12-1/8"W x 22"D x 7-1/4"H



### Standard Single Flat Side Burner

Part Number: BBQ08852P

When you need another heat source for cooking, the standard single flat side burner is an excellent solution!

**Dimensions:**

12-1/2"W x 20-3/8"D x 5-1/2"H

**Cut Out Dimensions:**

11-1/4"W x 17-5/8"D x 3-5/8"H

## DROP-IN ACCESSORIES



### Stainless Steel Sink w/ Faucet & Soap Dispenser

Part Number: BBQ11963

Keep your hands and utensils clean with this stainless steel sink with cold water and soap dispenser.

**Dimensions:**

15"W x 15"D x 6-1/4"H (17-1/4" Plunge)

**Cut Out Dimensions:**

14-1/4"W x 14-1/4"D x 7"H



### Hibachi Drop-In Grill-LP

Part Number: BBQ13900P

Grilled foods are easy with the hibachi drop-in grill. You'll be enjoying eggs, pancakes and stir-fry in no time!

**Dimensions:**

24"W x 24-7/8"D x 11-1/2"H

**Cut Out Dimensions:**

23-1/4"W x 22-1/4"D x 9-1/2"H



### Power Burner Drop-In Grill-LP

Part Number: BBQ10955P

Need a meal cooked fast or are you preparing something large? The power burner drop-in grill is your solution!

**Dimensions:**

19"W x 22-5/8"D x 12-1/2"H

**Cut Out Dimensions:**

18"W x 20-3/8"D x 9-1/4"H



### 12" Drop-In Food Warmer

Part Number: BBQ07888P

Turn your outdoor kitchen into the ultimate buffet with this 12" drop-in food warmer with three useful compartments!

**Dimensions:**

13-1/4"W x 25-1/4"D x 8-1/2"H

**Cut Out Dimensions:**

12-1/4"W x 21-1/2"D x 7-1/4"H





## DROP-IN ACCESSORIES



### 12" Cocktail Center

Part Number: BBQ12842P-12

Keep ice in a convenient place with the 12" cocktail center which comes with a towel rack and bottle opener.

**Dimensions:**  
13"W x 23"D x 9-3/4"H  
**Cut Out Dimensions:**  
12"W x 22-3/8"D x 10"H



### 18" Cocktail Center

Part Number: BBQ11842P-18

Keep drinks refreshed with the 18" cocktail center which conveniently holds ice, condiments and ice scoops.

**Dimensions:**  
18"W x 25-3/4"D x 9-3/4"H  
**Cut Out Dimensions:**  
17-1/4"W x 24-1/4"D x 10"H



### 30" Drop-In Bar Center

Part Number: BBQ07902

Turn your island into a bar with this 30" cocktail center, which holds ice and condiments and features a sink!

**Dimensions:**  
30"W x 22-1/4"D x 10-3/8"H  
**Cut Out Dimensions:**  
29-1/4"W x 22-1/2"D x 10-1/2"H

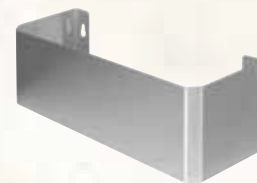

### 12" or 15" Spice/Juice Rack

12" Part Number: BBQ07846P-18  
*(Fits 18" & 30" Access Doors)*

15" Part Number: BBQ07846P-30  
*(Fits 30" Drop-In Bar Center)*

Keep all of your juices and spices handy while you grill with this convenient spice/juice rack! Own it today!

**Dimensions:**  
12"W x 4-3/4"D x 4-3/4"H  
15"W x 4-3/4"D x 4-3/4"H



### Drop-In Ice Bucket

Part Number: BBQ11864

Convenient way to store ice for all your backyard festivities. Comes with 20.82" x 14.20" lid and drain.

**Dimensions:**  
17"W x 23-3/4"D x 14-1/4"H  
**Cut Out Dimensions:**  
21"W x 24"D x 14-1/2"H



### Stainless Steel Cleaner & Polishing Towel

Part Number: BBQ25000386

Removes greasy film and watermarks. Resists fingerprints and streaking. Repels water; preserves surface while protecting against deterioration.

### Utensil set with Apron and Glove

Part Number: BBQ11100082

Utensil Set includes (3) Stainless Steel BBQ Utensils, (1) Apron, (1) BBQ Mitt, and (1) Utensil Carrying Bag

### BBQ Built In Grills Universal Adjustable Cover

Part Number: BBQC2345BB

This cover keeps any Cal Flame grill looking its best by protecting it against weather damage. Cover fits up to 2,3,4 & 5 burner grills.



# BARBECUE ISLAND ACCESSORIES

Cal Flame provides several storage solutions for keeping spices, cooking utensils, propane, aprons and everything else nearby.

## DOORS & DRAWERS



### 18" Vertical Door

Part Number: BBQ09841P-18

This durable 18" stainless steel vertical door will keep all your BBQ gadgets and necessities hidden.

**Dimensions:**

18"W x 20"H

**Cut Out Dimensions:**

15-1/2"W x 17-1/2"H



### 27" Horizontal Door

Part Number: BBQ07841P-27

This beautiful 27" horizontal door is perfect for islands that won't accommodate double doors.

**Dimensions:**

27"W x 20"H

**Cut Out Dimensions:**

24-1/2"W x 17-1/2"H

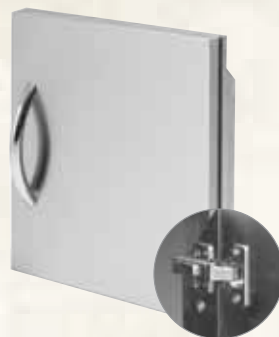

### 18" Single Access Door

Part Number: BBQ10839P-18

This heavy-duty 18" door is constructed from stainless steel and is perfect for most islands!

**Dimensions:**

17-3/4"W x 20-3/4"H x 1-1/4"D

**Cut Out Dimensions:**

16-1/2"W x 19-1/2"H



### 30" Double Access Door

Part Number: BBQ10839P-30

These durable 30" double doors are perfect for when you need to store large items inside your BBQ island!

**Dimensions:**

30"W x 20-3/4"H x 2"D

**Cut Out Dimensions:**

28-1/2"W x 19-1/4"H



### Towel Holder Rack

Part Number: BBQ08000500

For the ultimate in convenience add this towel holder rack to your 18" or 30" Access Doors. Add one or more!

**Dimensions:**

11-3/4"W x 4-3/4"H



### 18" Door & Drawer Combo

Part Number: BBQ11840P-18

This 18" door and drawer combo lets you to keep your barbecue tools protected from the elements. Add it today!

**Dimensions:**

18"W x 20-3/4"D x 20-3/4"H

**Cut Out Dimensions:**

17-1/8"W x 20-1/2"D x 19-1/4"H



### 30" Door & Drawer Combo

Part Number: BBQ11840P-30

This 30" combo incorporates two internal pull-out drawers and pull-out propane tray in a sealed enclosure.

**Dimensions:**

30" W x 20-5/8" D x 22" H

**Cut Out Dimensions:**

29-1/4" W x 20-1/2" D x 19-1/4" H



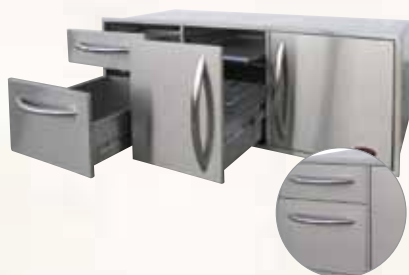

### Complete Utility Storage Set

Part Number: BBQ07909

This complete utility storage set separates your food and features a tray to keep your propane or waste basket on.

**Dimensions:**

52-1/2"W x 20-3/4"D x 20-3/4"H

**Cut Out Dimensions:**

51-1/2"W x 19-1/2"D x 20-3/8"H



### 2 Drawer Horizontal

Part Number: BBQ08867

Keep your important grilling tools, like spatulas, tongs and brushes close by with this 2 drawer horizontal accessory.

**Dimensions:**

39-1/4"W x 20-1/2"D x 10"H

**Cut Out Dimensions:**

37-3/4"W x 8-1/2"H



### 2 Drawer Storage Deep Drawer

Part Number: BBQ07868P

You'll enjoy this 2 drawer storage set which offers deep dimensions for oversized grilling tools like tongs and forks.

**Dimensions:**

13-1/8"W x 20-1/2"D x 20-3/4"H

**Cut Out Dimensions:**

10-1/2"W x 19-3/4"D x 17-3/8"H



### 3 Drawer Storage Wide

Part Number: BBQ08866

You can never have enough outdoor cooking storage. This 3 drawer storage accessory offers wide dimensions.

**Dimensions:**

18"W x 20-1/2"D x 20-3/4"H

**Cut Out Dimensions:**

15-1/4"W x 20-1/4"D x 17-1/4"H



### Paper Towel Storage Door

Part Number: BBQ07910

Spills and splatters are never an issue when you have paper towels close by with this paper towel storage door!

**Dimensions:**

10-1/2"W x 6-1/4"D x 16-1/2"H

**Cut Out Dimensions:**

8-1/2"W x 14-1/4"H



### Propane Tank Drawer

Part Number: BBQ07857P

Store your BBQ grill fuel in an elegant way with this convenient propane tank drawer that features a slide-out tray!

**Dimensions:**

16-5/8"W x 16-5/16"D x 22-5/8"H

**Cut Out Dimensions:**

14-3/4"W x 16-1/2"D x 20-1/4"H

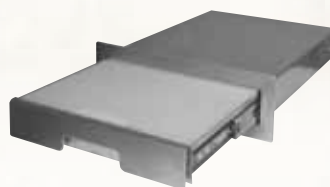

### Pull Out Cutting Board

Part Number: BBQ07891P

Every outdoor chef needs a place for cutting food. This pullout cutting board is perfect for all your cooking needs.

**Dimensions:**

15-3/8"W x 19-1/2"D x 4-3/4"H

**Cut Out Dimensions:**

13-1/4"W x 19-5/8"D x 2-7/8"H



### Bottle Opener and Catcher

Part Number: BBQ07901

Open up a cold one easily with one hand thanks to this bottle opener that comes with a cap catcher!

**Dimensions:**

6-3/4"W x 2-1/2"D x 3-3/4"H



# BARBECUE ISLAND ACCESSORIES

Enjoy the convenience of a food warmer that discreetly hides itself in a drawer. Kids will love the electric pizza oven drawer that can also double as a dish warmer for keeping meals hot. Keep food fresh and ready for cooking or chill drinks with stainless steel refrigerators. Host keg parties in style with a built-in beer tap. Have sodas ready for the kids in the elegant beverage cooler. The Cal Flame ice maker ensures you never have to run to the store for more ice!

## OVEN & REFRIGERATORS



### 2-in-1 Oven–Warmer and Pizza Oven (110V)

Part Number: BBQ10967E

Whether you're baking a pizza or want to keep a plate of food warm, this 2-in-1 oven-warmer is the ideal solution!

**Dimensions:**

30"W x 21-1/4"D x 11-1/2"H

**Cut Out Dimensions:**

28-3/4"W x 20-1/4"D x 10"H

Includes pizza brick, 2 stainless steel serving pans with covers and removable rack.



### Stainless Steel Refrigerator

Part Number: BBQ09849P

The stainless steel refrigerator is perfect for keeping your beverages cold and your food fresh at all times.

**Dimensions:**

20-3/8"W x 21-1/2"D x 31-3/8"H

**Cut Out Dimensions:**

21"W x 32-1/4"H



### Beer Tap Refrigerator

Part Number: BBQ09843B

Impress your friends on game-day with this built-in beer tap refrigerator that will accommodate your keg.

**Dimensions:**

21-3/8"W x 25-3/8"D x 32-3/8"H

**Cut Out Dimensions:**

22"W x 34"H

## PORTABLE "SOUND OF MUSIC"



### Portable "Sound of Music" Audio Panel with Marine Grade iPod Stereo System

Part Number: BBQ12001

- 24" x 4 1/4" x 9" Stainless Steel Audio Panel – can be mounted to any surface, such as any BBQ Island, indoor/outdoor wall or inside a gazebo!
- Marine-Grade Stereo System with built-in iPod controls that conveniently charge and operate your iPod or iPhone, and two (2) 4-inch speakers
- iPod dock transmits RF audio to a high-output, high-range speaker system
- 72-watt weatherproof speakers
- Large IC-FM Tuner with improved reception
- Additional auxiliary port for other MP3 systems
- State-of-the-art remote control with Balance and Fader. Blue backlight display – displays FM station and iPod song titles, Preset FM stations





**Outdoor Stainless Steel Refrigerator**

Part Number: BBQ10710  
 Built to withstand the elements, the outdoor stainless steel refrigerator keeps your beverages cold in any kind of weather!

**Dimensions:**  
 14-3/4"W x 23"D x 33"H  
**Cut Out Dimensions:**  
 15-1/4"W x 24"D x 34"H



**Outdoor Stainless Steel Ice Maker**

Part Number: BBQ10700  
 You'll never have to leave the party to get ice with the outdoor rated ice maker. Add this accessory now!

**Dimensions:**  
 14-3/4"W x 24"D x 33"H  
**Cut Out Dimensions:**  
 15-1/4"W x 24"D x 34"H



**Outdoor Stainless Steel Beverage Cooler**

Part Number: BBQ10715  
 Refreshments are just as important as great food. Add this outdoor beverage cooler and never run out of drinks!

**Dimensions:**  
 14-3/4"W x 23"D x 32-1/2"H  
**Cut Out Dimensions:**  
 15-1/4"W x 24"D x 34"H







# A LA CART DELUXE BBQ CART

The A La Cart Deluxe comes with two drawers for storage, a bottom compartment for propane tank storage or additional space and includes the Bonus Accessory Package. It fits a Standard Single Flat Side Burner. All A La Cart barbecue carts require assembly.



## A La Cart Deluxe

Part Number: BBQ10445KDB

Shown with 5 Burner Convection Grill



### Stainless Steel Removable Tray

Carry meats to and from your grill

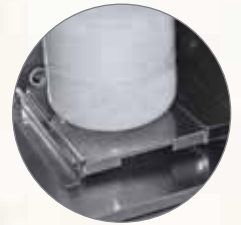

### Pull-Out Propane Tray

Each A La Cart Plus and A La Cart Deluxe comes with a pull-out propane tank tray—the easy way to load your tank. Standard equipment on A La Cart Deluxe and A La Cart Plus:

## Customize Your A La Cart

Select from any of our high-quality grills to complete your A La Cart Deluxe. Grill head and standard burner sold separately.

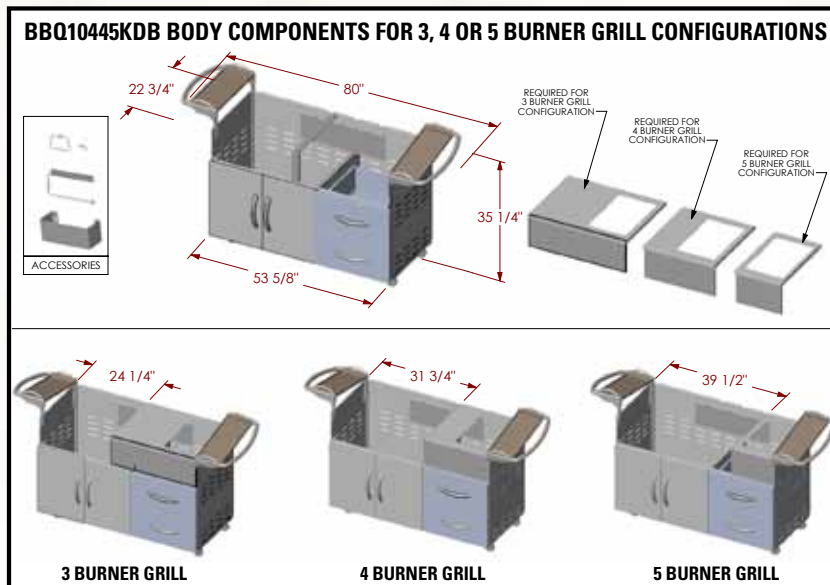

### Universal Grill Cover

The Universal Grill Cover features two adjustable straps which are easily adjusted to fit any Cal Flame built-in grill head.



### A La Cart Deluxe Optional Single Flat Side Burner

Part Number: BBQ08852P



# A LA CART PLUS BBQ CART

Short on space, but want a pro-style grill fit for a gourmet chef? Get the Cal Flame grill that you want in a convenient mobile grill cart. The A La Cart Plus includes two side serving trays, a spice rack, bottle opener, towel and paper towel holders and storage beneath for a propane tank and more.



**A La Cart Plus**  
Part Number: BBQ10345KDB  
Shown with 4 Burner G4 Grill



**Stainless Steel Removable Tray**  
Carry meats to and from your grill



## Customize Your A La Cart

Select from any of our high-quality grills to complete your **A La Cart Plus**. Grill head sold separately.

### BBQ09345KDB BODY COMPONENTS FOR 3, 4 OR 5 BURNER GRILL CONFIGURATIONS

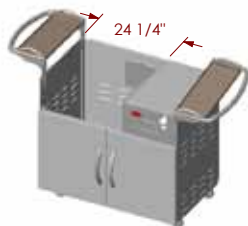
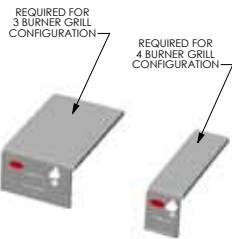
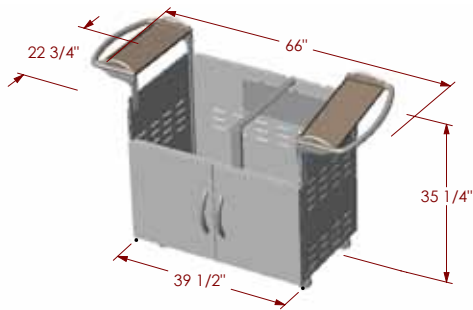
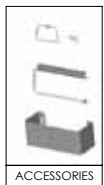

**3 BURNER GRILL**

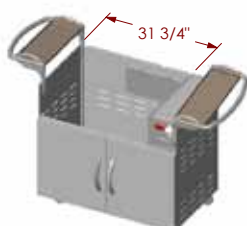

**4 BURNER GRILL**

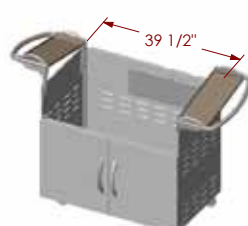

**5 BURNER GRILL**



**Towel Racks**  
Each A La Cart Plus and A La Cart Deluxe comes with a pull-out propane tank tray—the easy way to load your tank. Standard equipment on A La Cart Deluxe and A La Cart Plus



**Universal Grill Cover**  
The Universal Grill Cover features two adjustable straps which are easily adjusted to fit any Cal Flame built-in grill head.



# A LA CART BBQ CART

The sturdy A La Cart accommodates the grill of your choice—from the diminutive 3 Burner G3 Grill to the elite 5 Burner Convection Grill.



## A La Cart

Part Number: BBQ10245KDB  
Shown with 3 Burner G3 Grill

## Customize Your A La Cart

Select from any of our high-quality grills to complete your **A La Cart**. Grill head sold separately.

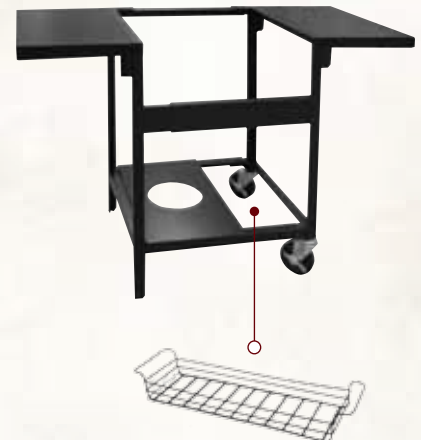

**Optional Basket**  
Add a basket to your A La Cart for extra storage area, fit up to three baskets depending on the size of your A La Cart.  
23" x 5-7/8" x 3"  
Part Number: BBQ10000330

### BBQ10245KDB BODY COMPONENTS FOR 3, 4 OR 5 BURNER GRILL CONFIGURATIONS

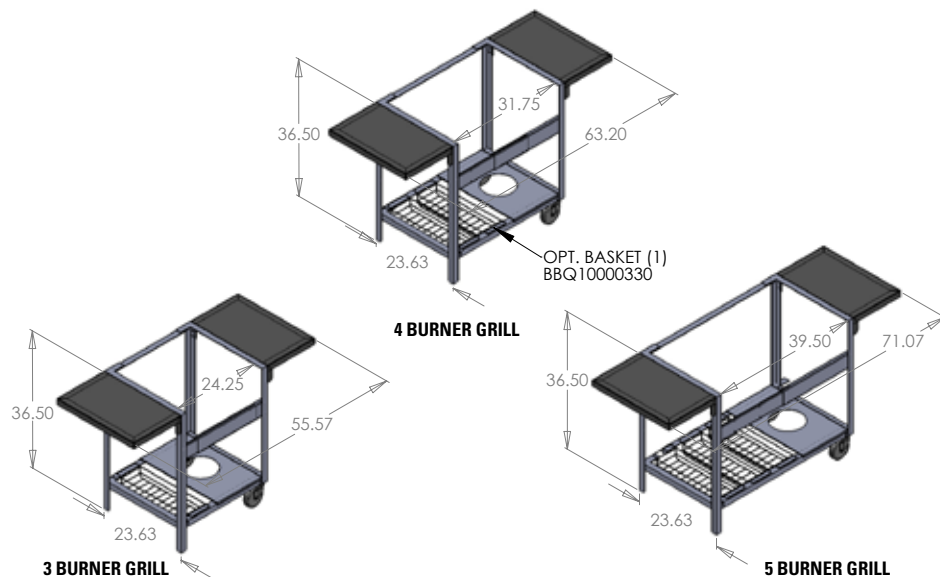

## Universal Grill Cover

The Universal Grill Cover features two adjustable straps which are easily adjusted to fit any Cal Flame built-in grill head.

All A La Cart barbecue carts require assembly.



# ANATOMY OF A BBQ ISLAND

Quality standards are at the core of every Cal Flame outdoor kitchen. From the inside out, the quality construction is undeniable. Each barbecue island begins with a sturdy metal frame constructed from commercial-grade 16-gauge galvanized steel. The island is then dressed in Hardibacker ceramic tile backer board for added durability and moisture resistance. Additionally, your outdoor kitchen is finished in the material of your choice and fitted with the cooking equipment you selected. Best of all, with premium electronic options to choose from, you can build a complete entertainment center outdoors!

## BUILT TO LAST

Designed for lasting durability and quality constructed out of premium outdoor-rated materials

## PROFESSIONALLY ENGINEERED

Cal Flame BBQ Islands are thoughtfully designed to bring the joy of cooking with emphasis on usable counter work space, ergonomic styling and storage need. Built to last for years of entertainment.

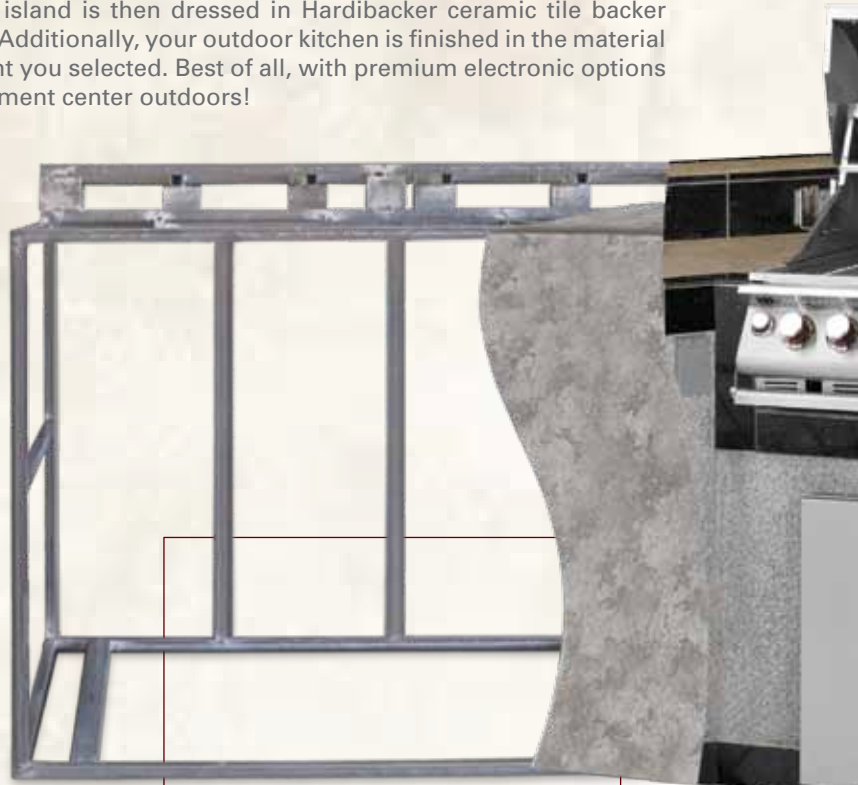
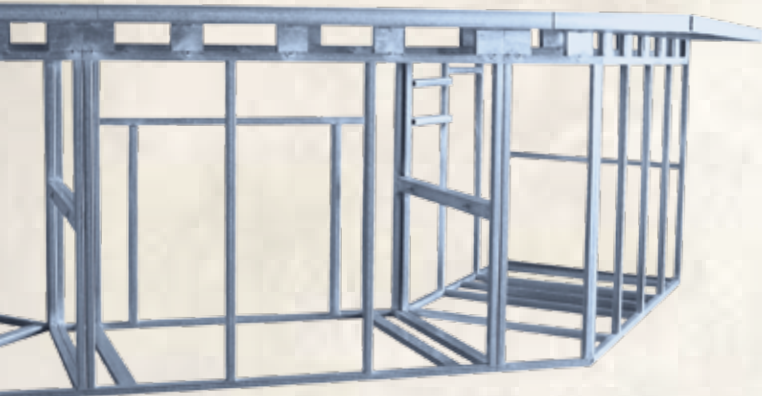

Shown with Natural Stone Field and Natural Stone Trim, One-Tone. Many colors to choose from.

### 16-GAUGE GALVANIZED STEEL FRAME

For long lasting integrity, the BBQ island frame is manufactured with fully-welded 16-gauge galvanized steel.

### HARDIBACKER CERAMIC TILE BACKER BOARD

Moisture-resistance and durability make Hardibacker ceramic tile backer board the perfect base to your create your island's customized finish.



### EXTERNAL ELECTRICAL OUTLET

Convenient electric sockets allow you to hook up accessories like blenders, fans and lamps.

## COUNTER TOP DESIGN STYLES



Natural Stone Tile



Two Tone Natural Stone Tile Design 1





**COUNTERTOP FINISHES**

Finish your countertop with granite, porcelain tile or natural stone tile. Tile options include single and two-tone styles. The choice is yours!

**LIGHTING (OPTIONAL)**

Nighttime dining and entertainment are illuminated by colorful LED lighting in your choice of colors.



**BASE FINISHES**

Choose from a wide selection of Ameristone Stucco and Cal Stone styles to complement your Home Resort design.

**BASE DESIGNS**

Outdoor kitchens finished in American Stucco can be accented by assorted tile designs—including trees, geometric patterns and sea life.

**VENTILATION**

Vents are built into the base of every outdoor kitchen to allow heat and trapped gas to escape and also makes clean-up quick.



**STEREO SYSTEMS (OPTIONAL)**

Complete the backyard or garden party with an outdoor-grade Sony stereo system blasting your personal mix from marine-grade 6-inch Sony speakers.

**AMERISTONE STUCCO**

- Weather resistant and beautiful Ameristone stucco comes in different choices to complement any décor
- Ameristone adheres more securely than traditional stucco for a finish that lasts even longer



**UMBRELLA HOLE (OPTIONAL)**

Umbrella hole is cut directly into the counter and trimmed with a stainless steel ring and stabilizing base. \*Fits most outdoor umbrellas



**SOLID FOOT REST (OPTIONAL)**

Footrests provide a convenient relief area during grill-side dining and entertaining.



**3-INCH BOTTOM TRIM (OPTIONAL)**

Provide a complete enhanced look to your outdoor kitchen while protecting the base of your island for extra strength and durability.



# CUSTOM PAVILION BBQ ISLANDS

Build the ultimate custom outdoor kitchen. You pick the size, shape, design and equipment that meets your needs and satisfies your desires. Available Designs: 6' Base Designs: 8' Base Designs: 10' Base Designs.



## Grand Pavilion **GPV3100**

**Overall Area Dimensions:**  
190" W x 84-1/2" D



Visit the Cal Flame website for more detailed information and dimensions.

*Grand Pavilion and Pavilion Islands are customizable and can fit any 3, 4 or 5 burner grill and selected accessory combination.*





**Grand Pavilion GPV3032**  
**Overall Area Dimensions:**  
 134-1/2"W x 52"D

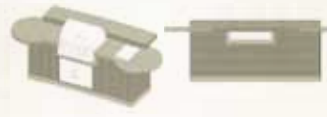

**Pavilion PV7000**  
**Overall Area Dimensions:**  
 126"W x 66-1/2"D



**Pavilion PV6016**  
**Overall Area Dimensions:**  
 73-3/4"W x 46"D



**Pavilion PV6004**  
**Overall Area Dimensions:**  
 73-3/4"W x 33-3/4"D



# LUXURY BACKYARD KITCHEN BBQ ISLANDS

Build the outdoor kitchen of your dreams with Cal Flame! Choose the size and color options that meet your needs and complement your lifestyle. Available Designs: 4' Base Designs, 6' Base Designs, and 8' Base Designs.



LBK **870** R/L

Overall Area Dimensions:  
111-1/2"W x 102-1/2"D

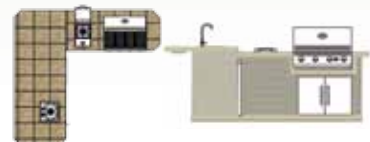

Visit the Cal Flame website for more detailed information and dimensions.







**LBK 830 R/L**  
 Overall Area Dimensions:  
 96"W x 72-1/2"D



**LBK 820 R/L**  
 Overall Area Dimensions:  
 95-1/2"W x 48-1/2"D



**LBK 810**  
 Overall Area Dimensions:  
 95-1/2"W x 36-3/4"D

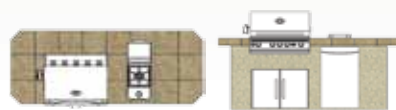

**LBK 801**  
 Overall Area Dimensions:  
 95-1/2"W x 36-3/4"D

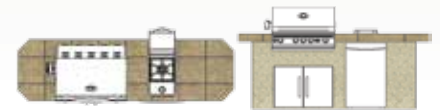

# LUXURY BACKYARD KITCHEN BBQ ISLANDS

Build the outdoor kitchen of your dreams with Cal Flame! Choose the size and color options that meet your needs and complement your lifestyle. Available Designs: 4' Base Designs, 6' Base Designs, and 8' Base Designs.



**LBK 710**  
Overall Area Dimensions:  
83-1/2" W x 36-3/4" D



Visit the Cal Flame website for more detailed information and dimensions.





**LBK 701**

Overall Area Dimensions:  
83-1/2"W x 27"D

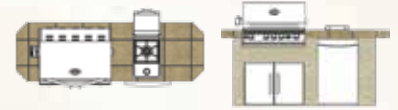

**LBK 601**

Overall Area Dimensions:  
70-3/4"W x 27"D



**LBK 401 R/L**

Overall Area Dimensions:  
70-1/2"W x 66"D

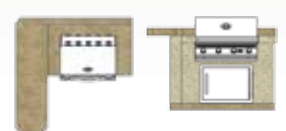



# ANATOMY OF A FIREPLACE

Cal Flame outdoor fireplaces add a sense of enchantment, magic and nostalgia to any backyard or garden. Homeowners will enjoy the beauty and dynamics that a fireplace brings to their Home Resort while guests will appreciate the year-round nighttime entertainment. Every Cal Flame fireplace is constructed to the highest standard, utilizing a 16-gauge galvanized steel frame and reinforced by Hardibacker tile backer board. Your fire fixture will be a source of elegance and entertainment for years to come.

## EXTENDED CHIMNEY

Selecting the correct chimney and designing the layout of the installation is critical to good performance. The taller the chimney, the more draft it will produce at a given temperature difference.

## FIREBOX 36-INCH ARCH DESIGN

Metal with fiberglass panels and straight firebox. Available on all fireplaces except FRP-905.

## STAINLESS STEEL BURNER

Light up the night and drive away the cold with a powerful 55,000 BTUs of heat.

## GRATE

All Cal Flame fireplaces benefit from this 18-inch grate which supports standard fire logs.

## LAVA ROCKS

As a standard feature on all natural gas or liquid propane fireplaces, Lava rocks accent the base of the firebox.

## FIRE LOGS

Decorative logs come standard with 36-inch fireboxes. Log sizes are measured by the front largest log in the set: • 36-Inch Firebox: 7 logs, 24-inch.

## ON/OFF SWITCH

Every fireplace switch utilizes a Piezo ignition system, which is a battery-powered electronic ignition.

## LIQUID PROPANE AND NATURAL GAS CONVERTIBLE

For your convenience, Cal Flame fireplaces can take advantage of your choice of fuel.

## SIMULATED STONE ARCH

Add a touch of distinction with a simulated stone arch. Available on 906, 907, 908, 909, 910 and 915.

## MANTLE

Decorate your fireplace with your favorite knick-knacks or plants. Available in Natural Stone Tile, Porcelain Tile or Bedrock® Panel.

## WRAPPED BOTTOM MANTLE

This mantle wraps around the front and sides of the fireplace creating more room for personal decorations. Available in Natural Stone Tile, Porcelain Tile or Bedrock® Panel.

## EXTENDED BOTTOM MANTLE

Accent the base of your fireplace with a sophisticated extended base in front of the firebox. Available in Natural Stone Tile, Porcelain Tile or Bedrock® Panel.



**FRP-908-1 As Shown:**  
Bedrock® Panel Top Mantel, Bedrock® Panel Rounded Arch 36", No Bottom Mantel



**FRP-908-2 As Shown:**  
Tiled Top Mantel, Bedrock® Panel Rounded Arch 36" Extended Bottom Mantel\*

\*NOTE: THE EXTENDED BOTTOM MANTLE ADDS APPROXIMATELY 12" IN DEPTH

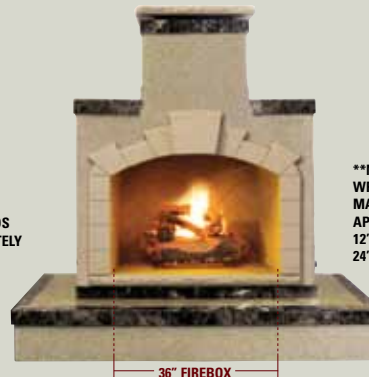

**FRP-908-3 As Shown:**  
Tiled Top Mantel, Bedrock® Panel Rounded Arch 36" Wrapped Bottom Mantel\*\*

\*\*NOTE: THE WRAPPED BOTTOM MANTLE ADDS APPROXIMATELY 12" IN DEPTH AND 24" IN WIDTH



**STANDARD WITH FIREPLACES:**  
7 PIECE 24" FIRE LOGS



# FIREPLACE SERIES

Cal Flame outdoor fireplaces are the perfect way to extend the outdoor season and seek warmth in the great outdoors. The innovative Cal Flame outdoor fireplaces feature all the latest technology and allow you to enjoy cool evenings.



## FRP-915

BURNER BTU OUTPUT: 55,000  
DIMENSIONS\* WITH 36" FIRE BOX: 72"W X 28"D X 78"H

## FRP-910-3

BURNER BTU OUTPUT: 55,000  
DIMENSIONS\* WITH 36" FIRE BOX: 72"W X 38"D X 78"H

A Cal Flame outdoor fireplace instantly adds a warm glow to your outdoor home resort, creating a calm, inviting ambiance. Cal Flame outdoor fireplaces can be customized to fit your personal taste and complement any backyard landscape. Designed with the finest material and craftsmanship, Cal Flame outdoor fireplaces are built to withstand all outdoor elements for years of enjoyment. Cal Flame outdoor fireplaces feature a fully welded 16-gauge galvanized stainless steel, sturdy one-piece construction, ETL approval and have a liquid propane/natural gas option. Enjoy the warmth of Cal Flame today!

Customize with your choice of Ameristone Stucco in 5 different Colors, or 8 beautiful optional Cultured Stone styles. Accent Trim with Porcelain Tile or Natural Stone Tile.



**FRP-910-1**  
DIMENSIONS\* WITH 36" FIRE BOX:  
48"W X 28"D X 78"H



**FRP-910-2**  
DIMENSIONS\* WITH 36" FIRE BOX:  
48"W X 38"D X 78"H





**FRP-909-3**

BURNER BTU OUTPUT: 55,000  
 DIMENSIONS\* WITH 36" FIRE BOX: 72"W X 38"D X 78"H



**FRP-909-1** DIMENSIONS\* WITH 36" FIRE BOX: 48"W X 28"D X 78"H  
**FRP-909-2** DIMENSIONS\* WITH 36" FIRE BOX: 48"W X 38"D X 78"H

**FRP-908-3**

BURNER BTU OUTPUT: 55,000  
 DIMENSIONS\* WITH 36" FIRE BOX: 72" W X 38" D X 78" H



**FRP-908-1** DIMENSIONS\* WITH 36" FIRE BOX: 48"W X 30"D X 78"H  
**FRP-908-2** DIMENSIONS\* WITH 36" FIRE BOX: 48"W X 40"D X 78"H

**FRP-906-3**

BURNER BTU OUTPUT: 55,000  
 DIMENSIONS\* WITH 36" FIRE BOX: 72"W X 38"D X 59"H



**FRP-906-1** DIMENSIONS\* WITH 36" FIRE BOX: 48"W X 28"D X 59"H  
**FRP-906-2** DIMENSIONS\* WITH 36" FIRE BOX: 48"W X 38"D X 59"H







# ANATOMY OF A FIREPIT

Whether it's a campfire in the woods, a bonfire at the beach or a firepit in the privacy of an outdoor Home Resort, people have enjoyed the relaxing and meditative properties of an open fire. Cal Flame captures that magic of fire in every firepit, which is constructed with 16-gauge galvanized steel and Hardibacker tile backer board for support and moisture resistance. Cal Flame firepits offer lasting and vibrant nighttime entertainment that can't be beat.

## STAINLESS STEEL BURNER

The powerful burner emits 55,000 BTUs and will easily keep everyone around the firepit comfortable on a chilly night.

## FIRE LOGS AND LAVA ROCKS

All Cal Flame firepits come equipped with a 4-piece fire log set as well as lava rocks or give your fire rustic naturalness.

## TABLETOP FIRE

For the ultimate in outdoor entertainment and relaxation, tabletop firepits can accommodate up to six guests. The innovative FPT-G5000 features a two-piece glass top and elegant footrest that will add lasting beauty and variety to your Home Resort.

## SHAPES

Firepits come in round, square, hexagonal (6-sided) and octagonal (8-sided) shapes to accommodate any backyard preference.



## LIQUID PROPANE OR NATURAL GAS CONVERTIBLE

Use liquid propane tanks or have a natural gas line professionally installed.

## HEIGHT

Firepits are available from 18" in height to replicate the campfire experience to 45" in height to create a conversational area that will accommodate full-height barstools. The choice is yours!

## ON/OFF SWITCH

Every fireplace switch utilizes a Piezo ignition system, which is a battery-powered electronic ignition.



# FIREPIT SERIES

Fire has always attracted people with its natural ability to warm, comfort and entertain. It is nothing short of magical. Cal Flame shares that magic with you and your family by offering the finest in outdoor fire fixtures.



Customize with your choice of Ameristone Stucco in 5 different Colors. 8 beautiful Cultured Stone styles to choose from. Accent Trim with Porcelain Tile or Natural Stone Tile. Also available on selected models: LED Lighting, multi-setting light show or simply program to your favorite single color. Liquid propane and natural gas option available.



## FPT-RT502

\*CUSTOMIZE TO YOUR DECOR

**BURNER BTU OUTPUT:** 55,000  
**DIMENSIONS:** 48" W x 72" D x 35" H  
**STANDARD FEATURES:** Ameristone Stucco, Porcelain Tile, 4 Piece Log Set w/ Lava Rocks, LP/NG Convertible



## FPT-H402

\*CUSTOMIZE TO YOUR DECOR

**BURNER BTU OUTPUT:** 55,000  
**DIMENSIONS:** 55" W x 48" D x 35" H  
**SHOWN WITH:** Ameristone Stucco, Porcelain Tile, 4 Piece Log Set w/ Lava Rocks, LP/NG Convertible



## FPT-RT501

\*CUSTOMIZE TO YOUR DECOR

**BURNER BTU OUTPUT:** 55,000  
**DIMENSIONS:** 48" W x 72" D x 20" H  
**STANDARD FEATURES:** Ameristone Stucco, Porcelain Tile, 4 Piece Log Set w/ Lava Rocks, LP/NG Convertible



## FPT-H401

\*CUSTOMIZE TO YOUR DECOR

**BURNER BTU OUTPUT:** 55,000  
**DIMENSIONS:** 55" W x 48" D x 20" H  
**STANDARD FEATURES:** Ameristone Stucco, Porcelain Tile, 4 Piece Log Set w/ Lava Rocks, LP/NG Convertible





SPECIAL ORDER ONLY

**FPT-G5000**

\*CUSTOMIZE WITH LED OPTION

**BURNER BTU OUTPUT:** 55,000  
**DIMENSIONS:** 69" R x 45" H  
**STANDARD FEATURES:** Tempered Glass Table Top, Ameristone Stucco - you choose from 5 colors, 4 Piece Log Set w/ Lava Rocks, LP/NG Convertible



**FPT-2500**

\*CUSTOMIZE WITH LED OPTION

**BURNER BTU OUTPUT:** 55,000  
**DIMENSIONS:** 69" R x 32" H  
**STANDARD FEATURES:** Tempered Glass Table Top, Ameristone Stucco - you choose from 5 colors, 4 Piece Log Set w/ Lava Rocks, LP/NG Convertible



**FPT-S302**

\*CUSTOMIZE TO YOUR DECOR

**BURNER BTU OUTPUT:** 55,000  
**DIMENSIONS:** 48" W x 48" D x 35" H  
**STANDARD FEATURES:** Ameristone Stucco, Porcelain Tile, 4 Piece Log Set w/ Lava Rocks, LP/NG Convertible



**FPT-R1050T**

\*CUSTOMIZE TO YOUR DECOR

**BURNER BTU OUTPUT:** 55,000  
**DIMENSIONS:** 61" R x 45" H  
**STANDARD FEATURES:** Ameristone Stucco, Porcelain Tile, 4 Piece Log Set w/ Lava Rocks, LP/NG Convertible



**FPT-S301**

\*CUSTOMIZE TO YOUR DECOR

**BURNER BTU OUTPUT:** 55,000  
**DIMENSIONS:** 48" W x 48" D x 20" H  
**STANDARD FEATURES:** Ameristone Stucco, Porcelain Tile, 4 Piece Log Set w/ Lava Rocks, LP/NG Convertible



**FPT-R1050S**

\*CUSTOMIZE TO YOUR DECOR

**BURNER BTU OUTPUT:** 55,000  
**DIMENSIONS:** 61" R x 35" H  
**STANDARD FEATURES:** Ameristone Stucco, Porcelain Tile, 4 Piece Log Set w/ Lava Rocks, LP/NG Convertible



# Cal Flame®

## THE HOME RESORT EXPERIENCE

Visit your Cal Flame dealer today and transform your backyard into a Cal Flame Home Resort with the world's largest and most complete selection of stylish outdoor living products that inspire the imagination, add value to your home and enhance your lifestyle.



Your Authorized Cal Flame Dealer:



1462 East Ninth Street, Pomona, CA 91766  
800-CAL-SPAS | [WWW.CALFLAMEBBQ.COM](http://WWW.CALFLAMEBBQ.COM)



©2014 Cal Flame, a division of LMS. All rights reserved. Cal Flame and Cal Spas are trademarks of LMS, Inc. All other brands, product names, company names, trade names, trademarks and service marks are the property of their respective owners, and are used with permission. Cal Flame reserves the right to enhance, modify or discontinue products at any time without notice. Specifications may change without notice. Dimensions are approximate. Products are manufactured under US patent. Patent numbers are available. Photographs and graphics are for illustration purposes only and may differ from actual product.

2369-14  
5.20.14

LTR2014BBQ-BR

